

**D-5200 Series (Continued)**

**D-5200S — Standard  
1-Row Type (Continued)**

**Mating Dimensions**

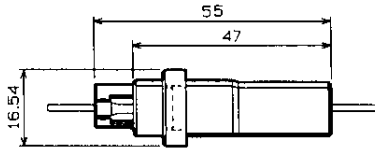

Panel / Free-hanging Type

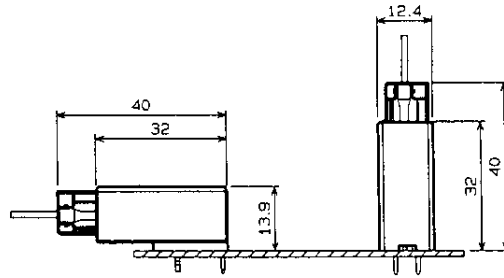

Horizontal / Vertical Type

**External Dimensions  
Receptacle Housing**

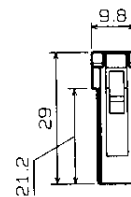
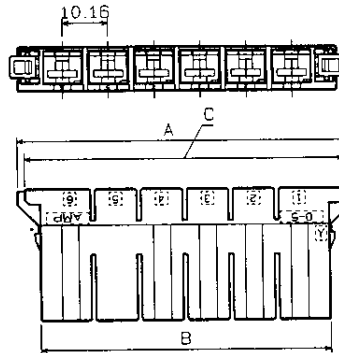
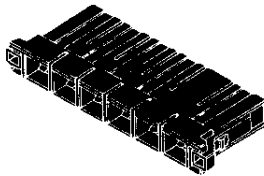

No. of Positions	Part Number of Receptacle Housing	Dimensions	
		A	B
2	□-179958-2	35.76	23.76
3	□-179958-3	45.92	33.92
4	□-179958-4	53.68	44.08
5	—	—	—
6	□-179958-6	74.00	64.40

**Tab Housing**

**Panel Type**

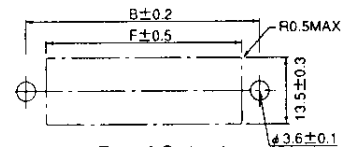
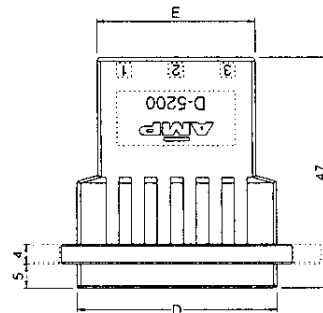
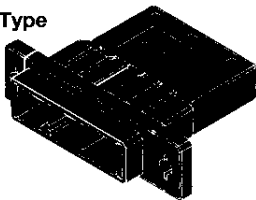

Panel Cutout

When mounting panel from the front, apply clamping torque of less than 49N [11 lbf].

**Free-hanging Type**

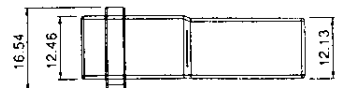
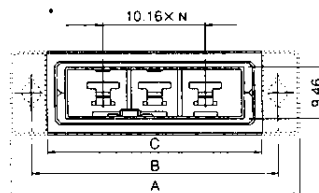
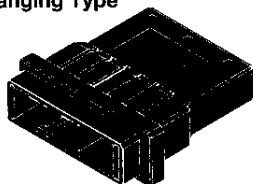

No. of Pos.	Part Number of Tab Housing		Dimensions					
	Panel Type	Free-hanging Type	A	B	C	D	E	F
2	□-353047-2	□-353046-2	47	38	33.44	29.36	21.11	30.4
3	□-353047-3	□-353046-3	57	48	43.6	39.52	31.27	40.5

**D-5200 Series** (Continued)

**D-5200M — Modular Type**  
(Continued)

**Mating Dimensions**

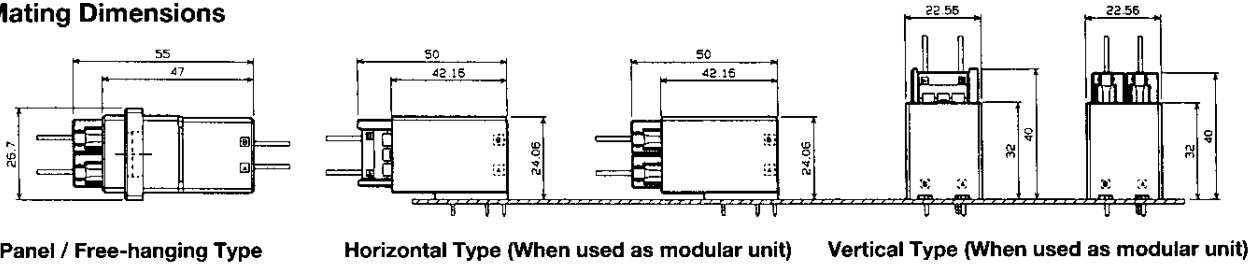

**External Dimensions**

■ Receptacle Housing

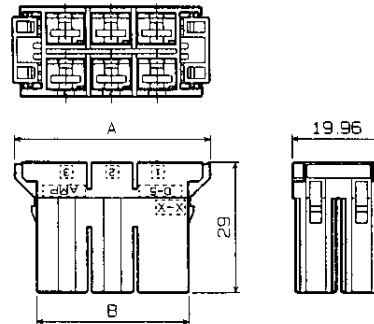
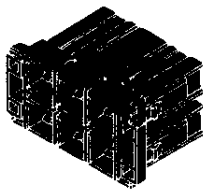

No. of Positions	Part Number of Receptacle Housing	Dimensions	
		A	B
4	□-917807-2	33.36	23.76
6	□-917807-3	43.52	33.92

■ Tab Housing

Panel Type

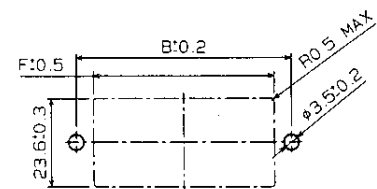
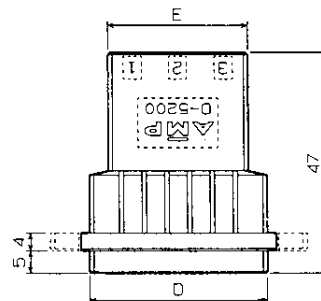
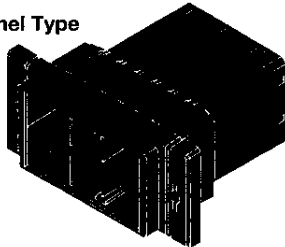

Panel Cutout

When mounting panel from the front, apply clamping torque of less than 49N [11 lbf].

Free-hanging Type

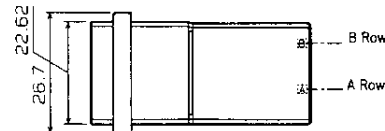
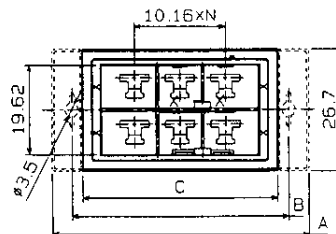
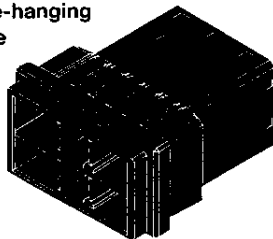

No. of Pos.	Part Number of Tab Housing		Dimensions					
	Panel Type	Free-hanging Type	A	B	C	D	E	F
4	□-917809-2	□-917808-2	47	38	33.44	29.36	21.11	30.40
6	□-917809-3	□-917808-3	57	48	43.60	39.52	31.27	40.50